

ELEMENTS

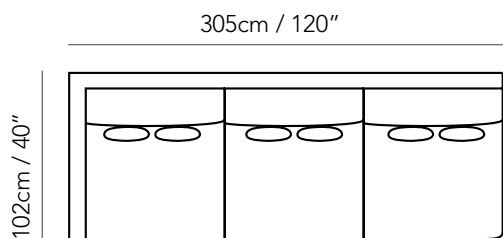

10523-120

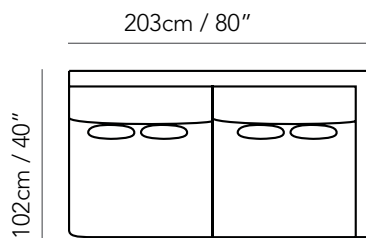

10514-80

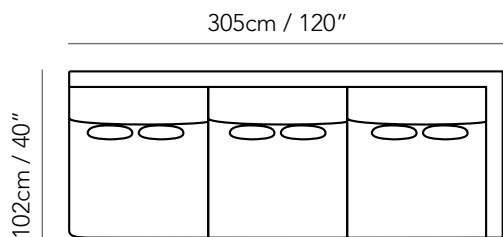

10524-120

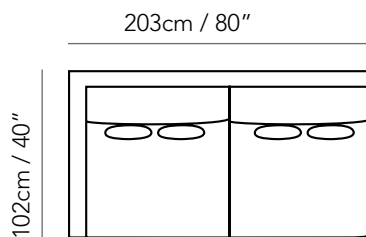

10513-80

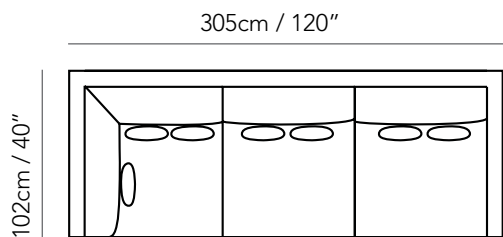

10526-120

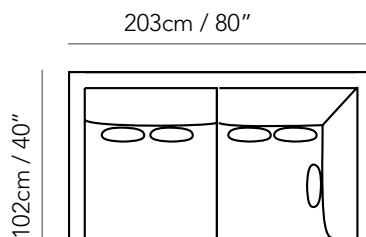

10515-80

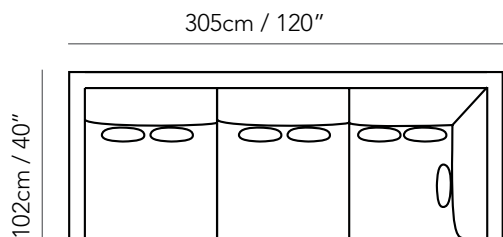

10525-120

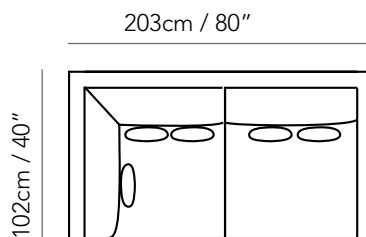

10516-80

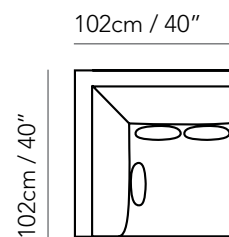

10505-40

ELEMENTS

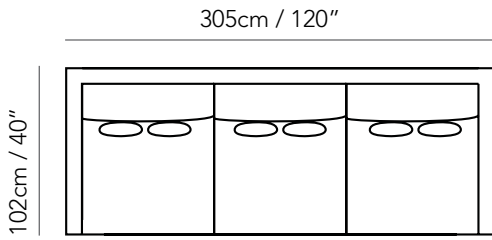

10521-120

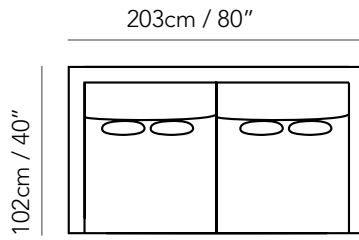

10511-80

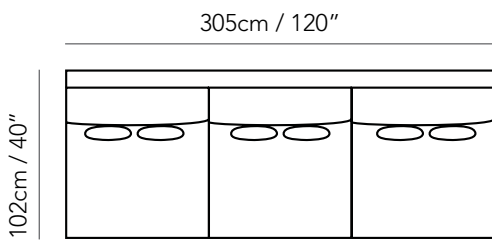

10522-120

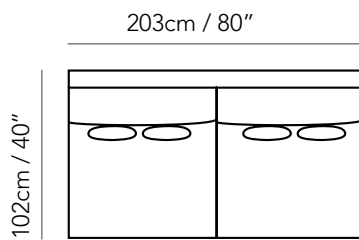

10512-80

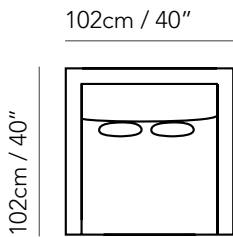

10501-40

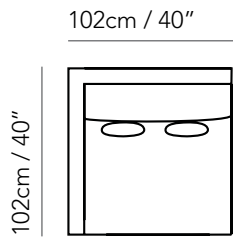

10503-40

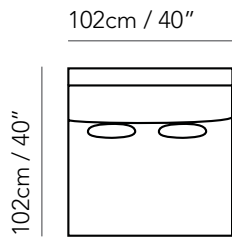

10502-40

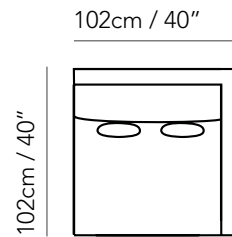

10504-40

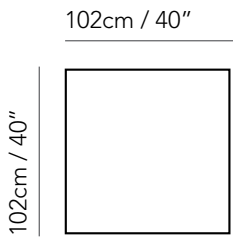

10501-11

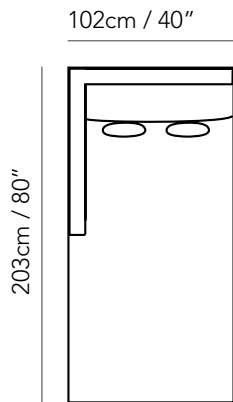

10533-40

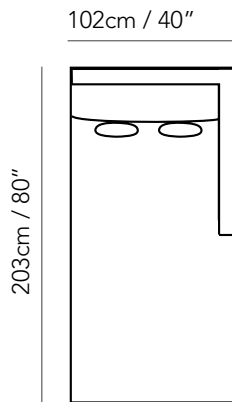

10534-40

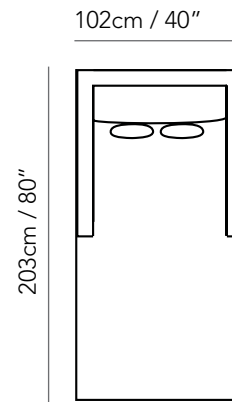

10531-40

COMBINATIONS

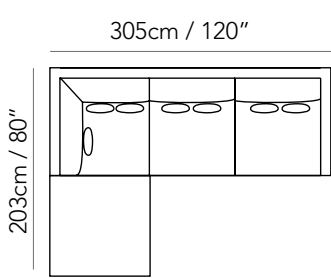

10501-11+10526-120

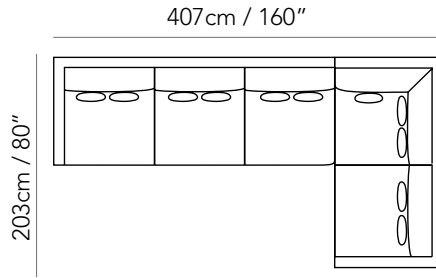

10523-120+10516-80

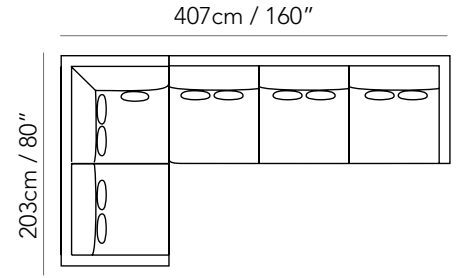

10515-80+10524-120

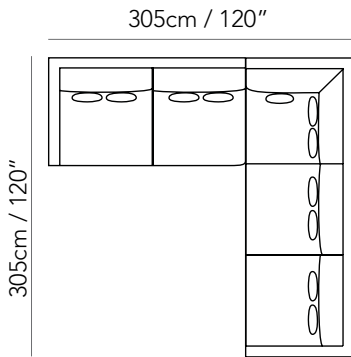

10513-80+10526-120

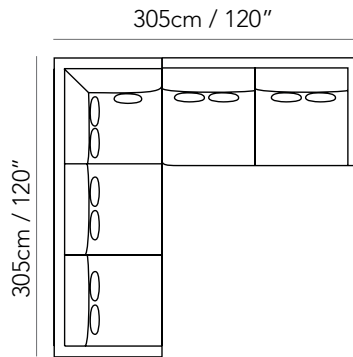

10525-120+10514-80

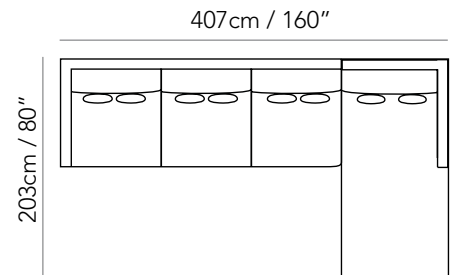

10523-120+10534-40

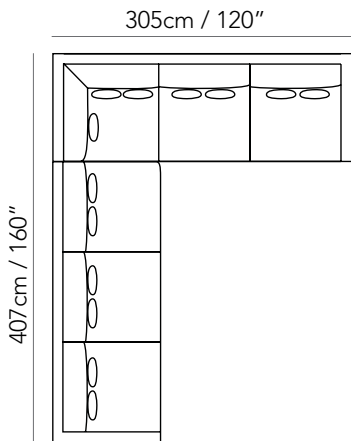

10523-120+10526-120

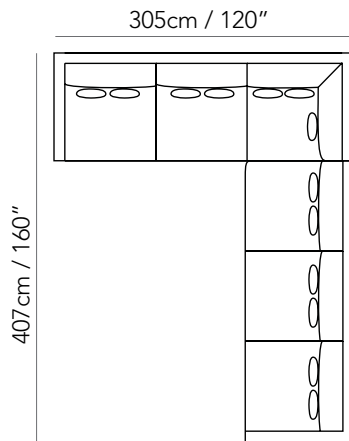

10525-120+10524-120

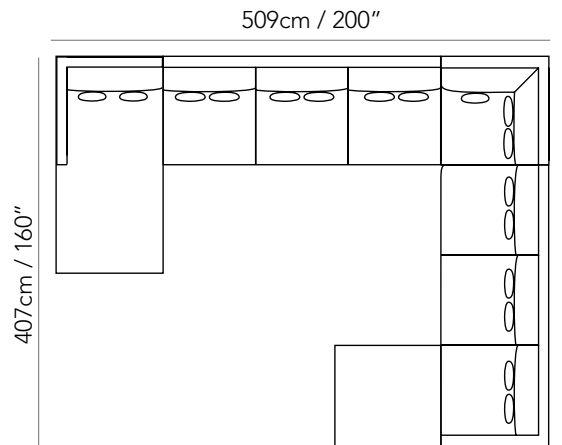

10533-40+10522-120+10505-40+
10524-120+10501-11